

Muli-Nova DDP

Product information for the product group

ACO Product benefits

- Tested in accordance with DIN EN 12050-1
- Freely selectable inlets
- Delivery heads of up to 30m possible
- 2 container sizes selectable (430/ 440l)
- Easy to maintain backflow preventer (patented)

- Scope
 - Multi-dwelling units
 - Office buildings
 - Industrial buildings
 - Behind separators up to NS20 - in connection with air bubble injection
- Polyethylene tank
 - Bottom outlet/ connection manual membrane pump R 1 1/2'
 - Inspection opening for easy maintenance, diameter: 250 mm
 - Fastening set for buoyancy-proof anchorage
 - DDP 1.x:
 - Horizontal inlet sockets 1x DN100, 1x DN 150
 - Vertical inlet sockets: 1x DN100, 3x DN150, 1x DN200, 1x DN100 (vent pipes)
 - DDP 2.x:
 - Horizontal inlet sockets 3x DN150
 - Vertical inlet sockets: 1x DN100, 2x DN150, 1x DN200, 1x DN100 (vent pipes)
 - In addition, freely selectable sockets per hole saw + seal
- Discharge line connection
 - Patented flap backflow preventer with lifting screw
 - Drain valve for easier draining
 - Special mounting adapter DN 80 for elastic connection of the discharge line with 108 - 114.3 mm outer pipe diameter (optional 88 - 93 mm)
 - Connecting flange for stop valve DN 80
- 2 pumps
 - 3-phase motor: 400 V, 50 Hz
 - Degree of protection IP 68
 - Blockage-free free flow impeller
 - 10 m connecting cable
- Level switching
 - Pneumatic level switching with 10 m control line
 - Optional: Pressure transducer
 - Optional: Air bubble injection (accessories) for measurement with pilot tube
- Tested in accordance with DIN EN 12050-1
- Approved delivery temperature up to 40 °C (short-term up to max. 65 °C)
- Control is not included in the scope of supply and must be ordered separately (see accessories)



Item Technical Data 3016810

| Type | Motor power | | Power consumption [A] | Key data | | | Usable volume | | | Total volume [l] | Weight [kg] |
|-------------------|-------------|------|--------------------------|----------------|----------------------|------------------------|------------------------|------------------|-----|---------------------|----------------|
| | P1 | P2 | | Voltage [V] | Rev count [r/min] | Inlet height Z1 [l] | Inlet height Z2 [l] | Top inlet [l] | | | |
| | [kW] | [kW] | | | | | | | | | |
| Muli-Nova DDP 1.3 | 6.3 | 5.5 | 11.2 | 400 | 2900 | 100 | 275 | 345 | 430 | 130 | |

Dimensions

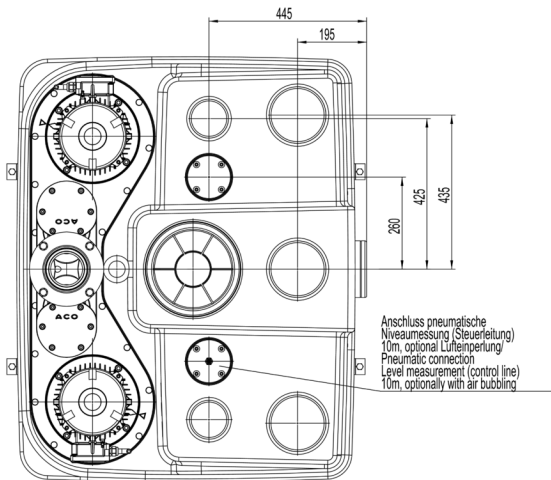
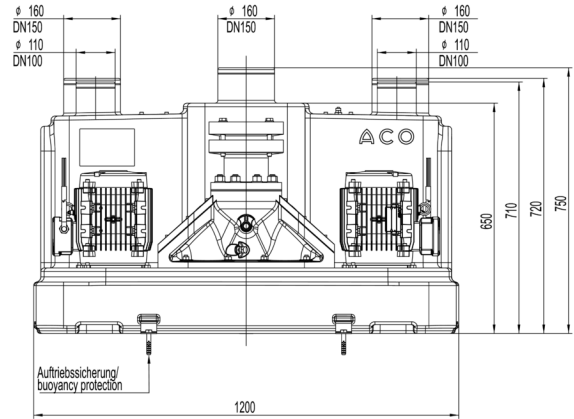
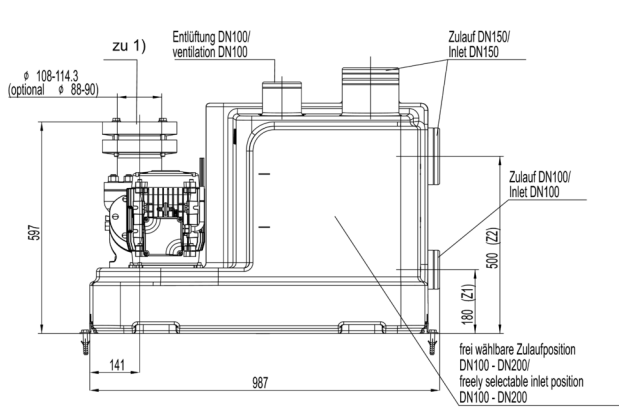

- 1) Spezialbefestigungsstück für den elastischen Anschluss der Druckleitung DN100/
Special fastening piece for elastic connection of the DN100 pressure line



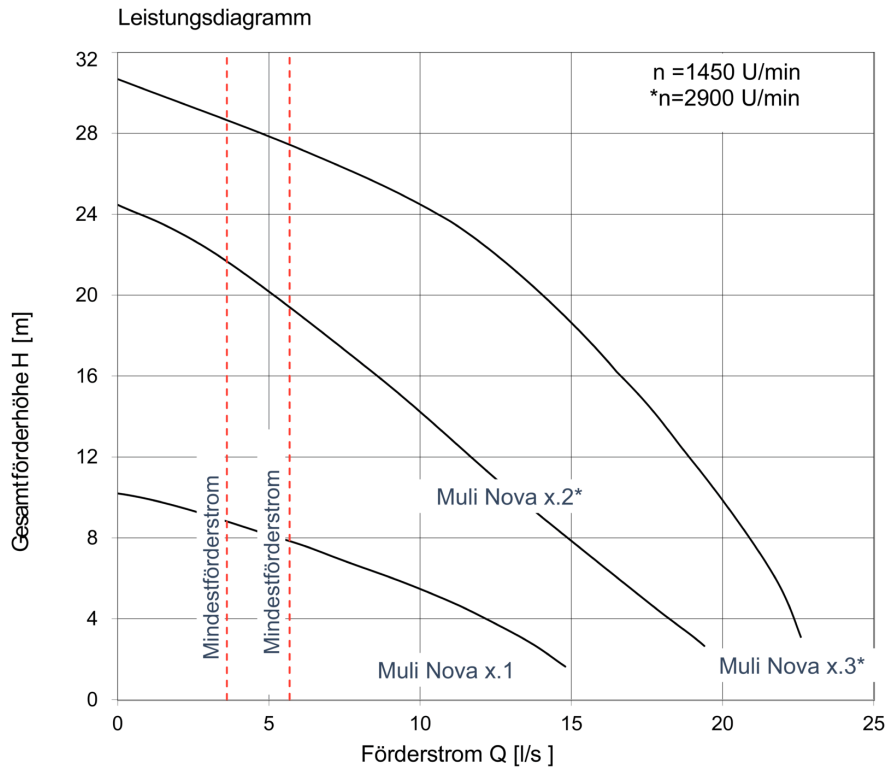

Schaltkasten (steckerfertig)/
Switch box (plug-in ready)
Kabel (1,5 m lang) mit CEE-Stecker 32A/
Cable (1.5m long) with CEE-connector 32A



Performance parameters















| Type | Deliv- ery head [m] | Delivery flow Q with overall delivery head H | | | | | | | | | | | Media tem- perature | | |
|--------------------------|------------------------------|--|-------|-------|-------|-------|-------|-------|-------|-------|-------|-------|------------------------|--------|--------------|
| | | 2 m | 4 m | 6 m | 8 m | 10 m | 12 m | 14 m | 16 m | 18 m | 20 m | 22 m | 24 m | Normal | Maxi- mum |
| | | [l/s] | [l/s] | [l/s] | [l/s] | [l/s] | [l/s] | [l/s] | [l/s] | [l/s] | [l/s] | [l/s] | [l/s] | [°C] | [°C] |
| Muli- Nova DDP 1.3 | 2 – 31 | 22.3 | 22.1 | 21.9 | 21.0 | 19.9 | 19.0 | 17.8 | 16.4 | 15.2 | 13.9 | 12.2 | 10.8 | 40 | 60 |





Accessories



| Description | Used with | Weight | PU | Item number |
|--|---|---|---------|-------------|
| | | [kg] | [piece] | |
| <ul style="list-style-type: none"> ■ For pumps up to 5,5 kW ■ Plug and use with 1.5 m mains cable ■ Operating voltage: 400 V ■ Frequency: 50/60 Hz ■ Control voltage: 230 V/AC ■ Current consumption when idling: max 10 VA ■ Temperature range: -20 to +60 ° C ■ IP 54 protection | | 5.4 | | |
|  | <p>Switching device, ACO Multi Control Duo Professional without Dynamic pressure bellWith Modbus RTU functionality for connection to the building management system; CEE 16 plug with phase-changing switch;</p> <p><input type="checkbox"/> Convertible to CEE 32 with item no. 0150.79.75 (5G4 with CEE 32 plug) ; 20 m pneumatic control cable 8 x 6 mm</p> | <p>Muli-Nova DDP; <input type="checkbox"/> Muli-Nova x.1 / x.2</p> | | 3014981 |
|  | <p>Switching device, ACO Multi Control Duo Professional without Dynamic pressure bellWith Modbus RTU functionality for connection to the building management system; CEE 32 plug with phase-changing switch; 20 m pneumatic control cable 8 x 6 mm</p> | <p>Muli-Nova DDP; <input type="checkbox"/> Muli-Nova x.3</p> | | 3017236 |
|  | <p>Switching device, ACO Multi Control Duo without Dynamic pressure bellCEE 16 plug with phase-changing switch;</p> <p><input type="checkbox"/> Convertible to CEE 32 with item no. 0150.79.75 (5G4 with CEE 32 plug) ; Without control line</p> | <p>Muli-Max; <input type="checkbox"/> Duo ; Powerlift-P; Muli-Flex; Muli-Nova DDP; <input type="checkbox"/> Muli-Nova x.1 / x.2</p> | | 0178.63.94 |
|  | <p>Switching device, ACO Multi Control Duo without Dynamic pressure bellCEE 32 plug with phase-changing switch; Without control line</p> | <p>Muli-Nova DDP; <input type="checkbox"/> Muli-Nova x.3</p> | | 3017237 |

| Description | Used with | Weight | PU | Item number |
|---|---|--------|---------|-------------|
| | | [kg] | [piece] | |
|  <p>Message system with GSM module</p> <ul style="list-style-type: none"> ■ Parameter via app (Android & iOS) ■ Mains-independent alarm via 12V lead-gel battery ■ Optical and acoustic alarm message ■ Freely configurable inputs <ul style="list-style-type: none"> □ 6 digital inputs with LED status display □ 1 analogue ■ 1 alarm output 12 V ■ Alarm forwarding via SMS to mobile phones ■ For mounting outside the hazardous area ■ Housing: 192 x 150(with cable gland) x 100 mm (WxHxD) ■ Protective doctor: IP54 ■ Operating voltage: 230 V/AC 50/60 Hz | <ul style="list-style-type: none"> ■ All grease separators ■ Grease layer thickness measuring device ■ Pre-tank plants ■ Technical processing systems ■ Quatrix-K backflow preventer type 3F ■ Sinkamat-K (underfloor) duo ■ Muli lifting units ■ Pumping stations ■ Installation sets | 2.0 | 1 | 0150.80.14 |
|  <p>Connection cable antenna GSM</p> <ul style="list-style-type: none"> ■ Length incl. connections: approx. 15 m ■ Cable type: RG58 ■ Connections: 1 x SMA plug (SMA/M) and 1 x SMA socket (SMA/F) ■ Only one extension cable may be used per GSM module ■ Usable in temperature range: -20°C to 85°C | ■ GSM - Modul | | | 0150.83.86 |
|  <p>Signalling unit</p> <ul style="list-style-type: none"> ■ Self-charging ■ With floating contact ■ Visual and acoustic ■ Without contact transmitter ■ For mounting outside the potentially explosive atmosphere ■ Dimensions: 175 x 125 x 75 mm W x H x D ■ Protection type: IP65 ■ Operating voltage: 230 V/AC 50/60 Hz ■ Ready to plug in with cable: 2 m | | | | |
| | Faecal matter backflow automatic stop Quatrix-K type 3F; All Muli wastewater lifting plants; Upstream tank plant mono/duo; Muli-Max; Sinkamat -K/-KD; Sinkamat-Z; Sinkamat-Z (underfloor); <input type="checkbox"/> Duo ; LipuLift-P | 1.4 | 1 | 0150.26.73 |

| Description | Used with | Weight | PU | Item number |
|---|---|--------|---------|-------------|
| | | [kg] | [piece] | |
|  <p>Connection and flood module set</p> <ul style="list-style-type: none"> ■ To report a leak caused for example by a pipe bursting ■ For electrically conducting liquids ■ With volt free contact ■ Visible and audible alarms (approx. 80 dB) ■ Dimensions (width x height x depth): 160 x 120 x 75 mm ■ Protection level: IP 65 ■ Operating voltage: 230 V/AC 50/60 Hz ■ Plug and use: 1.4 m ■ Overflow indicator with 10 m cable | <ul style="list-style-type: none"> ■ Triplex-K backflow stops <ul style="list-style-type: none"> □ DN 100 – DN 150 ■ Quatrix-K backflow stops ■ All wastewater lifting plants ■ All separators | 1.1 | 1 | 0150.78.97 |
|  <p>Signal horn</p> <ul style="list-style-type: none"> ■ Operating voltage: 12V DC ■ Power consumption: 30 mA ■ 62 x 62 x 85 mm (LxWxD) ■ Degree of protection: IP66 ■ Noise level: 95 dB(A) | <ul style="list-style-type: none"> ■ Signalling unit ■ Signalling unit with GSM module | 0.2 | | 0150.58.14 |
|  <p>Signal horn</p> <ul style="list-style-type: none"> ■ 230V AC ■ Power consumption: 30mA ■ Ø62x85 mm (L/B x T) ■ Protection: IP66 ■ 95 dB(A) | <ul style="list-style-type: none"> ■ Signalling unit with voltage-free fault reporting ■ LipuSmart-P ■ Multi-Max with signalling unit ■ LipuLift-P | 0.3 | 1 | 0178.61.94 |
|  | Flashing light | | | |
| 230V; Power consumption: 70 mA | Signalling unit with voltage-free fault reporting; LipuSmart-P; Multi-Max with signalling unit; LipuLift-P | 0.5 | 1 | 0178.62.08 |
| | | | | 0150.76.25 |
|  | <p>Air bubble injection</p> <ul style="list-style-type: none"> ■ To increase operational safety (where floating surfaces are generated e.g. grease separator) ■ For pneumatic level switching ■ Mini compressor <ul style="list-style-type: none"> □ Connection: 230 V □ Plug and use ■ With T-screw-in connection ■ With backflow valve | | | |
| | Multi-Max; Powerlift-P; Multi-Flex | 0.6 | | 0150.25.45 |
|  | <p>Pressure pick-up</p> <ul style="list-style-type: none"> ■ 4–20 mA ■ For secure switching cable lengths > 12 m ■ 0–200 mbar | | | |

| Description | Used with | Weight | PU | Item number |
|---|--|--------|---------|-------------|
| | | [kg] | [piece] | |
| With cable for installation: 20 m | Control ACO Multi-Control Mono/Duo; LipuLift-P/LipuLift-PF; Multi-Flex | 2.0 | | 0178.63.88 |
| Cable for installation: 40 m | Control ACO Multi-Control Mono/Duo; LipuLift-P/LipuLift-PF; Multi-Flex | 3.4 | | 0178.63.87 |
|  Float switch <ul style="list-style-type: none"> ■ Housing: PRE-ELEC PP ■ Degree of protection: IP68 ■ Switch voltage: 4-40 V ■ Switch current: 1-100 mA ■ Connection cable: 10m ■ Switch inclination: 10° ■ Protection class: II 1G Ex ia IIC T6 Ga | <ul style="list-style-type: none"> ■ For faecal and non-faecal wastewater ■ MultiControl controls as float switches ■ MultiControl controls as additional High alarm float | | | 0159.12.45 |
|  Safety barrier <ul style="list-style-type: none"> ■ To separate Ex-risk and secure areas ■ Incl. housing | <ul style="list-style-type: none"> ■ Pressure pick-off ■ Float switch with ATEX-certificate | | | |
| | | 0.5 | | 0178.63.89 |
|  Sealing ring <ul style="list-style-type: none"> ■ As additional component for pressure line DN 80 ■ Clamping range: 88 - 93 mm | <ul style="list-style-type: none"> ■ LipuSmart-P ■ Powerlift installation kit DN 100 ■ Fäkablock II ■ All Muli wastewater lifting plants | 0.3 | 1 | 0150.83.71 |
|  Stop valve DN 80 <ul style="list-style-type: none"> ■ Made of cast iron ■ 8 screws and nuts ■ 1 DN 80 seal ■ Length: 180 mm | <ul style="list-style-type: none"> ■ LipuSmart-P ■ Multi-Star MDP1/MWP1 ■ Multi-Star DDP 1/2 | 19.4 | 1 | 0154.51.93 |
|  Inlet valve DN 100 <ul style="list-style-type: none"> ■ Made out of PVC ■ Spigot Ø110 on both sides for sleeveless pipe systems made of cast iron or plastic ■ Total dimensions: 176 x 360 mm (L x H) | <ul style="list-style-type: none"> ■ Grease separator made of polyethylene ■ Starch separator made of polyethylene ■ Upstream tank systems type 2 and 4 ■ LipuMobil – type 0.5 | 5.9 | | 0175.31.87 |
|  Inlet valve DN 100 <ul style="list-style-type: none"> ■ Made of PVC ■ 110 mm push socket on both sides with rim sealing ring ■ Overall dimensions: 176 x 330 mm (L x H) | <ul style="list-style-type: none"> ■ Wastewater lifting plant ■ Polyethylene grease separator ■ Polyethylene starch separator ■ Upstream tank plant <ul style="list-style-type: none"> □ Typ 2 and 4 ■ LipuMobil-P – Type 0.5 | 3.1 | 1 | 0175.13.84 |
|  Inlet valve DN 150 <ul style="list-style-type: none"> ■ Made of PVC ■ 160 mm push socket on both sides with rim sealing ring ■ Overall dimensions: 226 x 510 mm (L x H) | <ul style="list-style-type: none"> ■ Wastewater lifting plant ■ Polyethylene grease separator ■ Polyethylene starch separator ■ Upstream tank plant <ul style="list-style-type: none"> □ Type 7 – Type 10 | 7.0 | 1 | 0175.13.85 |

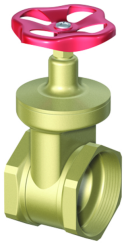
| | Description | Used with | Weight [kg] | PU [piece] | Item number |
|---|--|---|----------------|---------------|----------------|
|  | <p>Inlet valve DN 150</p> <ul style="list-style-type: none"> ■ Made out of PVC ■ Spigot Ø110 on both sides for sleeveless pipe systems made of cast iron or plastic ■ Total dimensions: 226 x 420 mm (L x H) | <ul style="list-style-type: none"> ■ Grease separator made of polyethylene ■ Starch separator made of polyethylene ■ Upstream tank systems type 7 to 10 | 10.2 | | 0175.31.88 |
|  | <p>Inlet valve DN 200</p> <ul style="list-style-type: none"> ■ Made out of PVC ■ Push socket 200 mm with lip sealing ring on both sides ■ Total dimensions: 264 x 637 mm (L x H) | <ul style="list-style-type: none"> ■ Wastewater lifting plant <ul style="list-style-type: none"> <input type="checkbox"/> Multi-Star DDP 1/2 ■ Grease separator made of polyethylene <ul style="list-style-type: none"> <input type="checkbox"/> From NS 15 | 8.4 | 1 | 0170.20.83 |
|  | | <ul style="list-style-type: none"> ■ Abwasserhebeanlage <ul style="list-style-type: none"> <input type="checkbox"/> Multi-Nova DDP | | | |
| | <p>Inlet seal DN 50ACO inlet seal DN 50; For insertion of an additional inlet; For pipe with OD 50 mm; Drilling diameter 59 mm</p> | | | | 3013641 |
| | <p>Inlet seal DN 70ACO inlet seal DN 70; For insertion of an additional inlet; For pipe with OD 75mm; Drilling diameter 86 mm</p> | | | | 3014479 |
| | <p>Inlet seal DN 100ACO inlet seal DN 100; For insertion of an additional inlet; For pipe with OD 110mm; Drilling diameter 125 mm</p> | | | | 3014478 |
| | <p>Inlet seal DN 150ACO inlet seal DN 150; For insertion of an additional inlet; For pipe with OD 160mm; Drilling diameter 175 mm</p> | | | | 3014477 |
| | <p>Inlet seal DN 200ACO inlet seal DN 200; For insertion of an additional inlet; For pipe with OD 200mm; Drilling diameter 215 mm</p> | | | | 3014476 |
| | <p>Inlet seal DN 250ACO inlet seal DN 250; For insertion of an additional inlet;; For pipe with OD 250mm;; Drill diameter 265 mm</p> | | | | 3014475 |
|  | <p>Hand membrane pump 1 1/2"</p> <ul style="list-style-type: none"> ■ For fixing to wall ■ Incl. hose <ul style="list-style-type: none"> <input type="checkbox"/> Clear width: 48 x 80 mm ■ Incl. hose clamp <ul style="list-style-type: none"> <input type="checkbox"/> Clear width: 50 x 70 mm <input type="checkbox"/> Width: 12 mm <input type="checkbox"/> 2 pcses required | <ul style="list-style-type: none"> ■ Wastewater lifting plant | 14.4 | 1 | 0175.23.73 |
|  | <p>Three way valve 1 1/2"</p> <ul style="list-style-type: none"> ■ For hand membrane pump | <ul style="list-style-type: none"> ■ Wastewater lifting plant | 3.3 | 1 | 0159.10.14 |

| Description | Used with | Weight | PU | Item number |
|--|----------------------------|--------|---------|-------------|
| | | [kg] | [piece] | |
|  <p>Stop valve 1 1/2" ■ For hand membrane pump</p> | ■ Wastewater lifting plant | 1.0 | 1 | 0159.10.12 |
|  <p>siphon</p> | | 0.7 | | 0174.02.29 |
| | | 1.3 | | 0174.02.30 |

You can find further accessories under → <https://www.buildingdrainage.aco/search/?q=3016810>